

<b>FR</b> Guide de l'utilisateur	<b>CS</b> Návod k použití	<b>LV</b> Lietošanas pamācība
<b>EN</b> User's guide	<b>SK</b> Používateľská príručka	<b>BG</b> Ръководство на потребителя
<b>DE</b> Bedienungsanleitung	<b>PL</b> Instrukcja obsługi	<b>AR</b> دليل الاستعمال
<b>NL</b> Gebruiksaanwijzing	<b>CS</b> Návod k použití	<b>KO</b> 사용자 가이드
<b>ES</b> Guía del usuario	<b>SK</b> Používateľská príručka	<b>BA</b> Korisnička uputstva
<b>PT</b> Guia del usuario	<b>HU</b> Használati útmutató	<b>RC</b> 使用指南
<b>IT</b> Manuale d'uso	<b>SL</b> Navodila za uporabnika	<b>HK</b> 使用指南
<b>DA</b> Brugsvejledning	<b>RU</b> Руководство пользователя	<b>FA</b> راهنمای کاربر
<b>NO</b> Bruksanvisning	<b>UK</b> Посібник користувача	<b>VN</b> Hướng dẫn dành cho người sử dụng
<b>SV</b> Användarhandbok	<b>HR</b> Upute za uporabu	<b>TH</b> คู่มือสำหรับผู้ใช้งาน
<b>FI</b> Käyttöopas	<b>RO</b> Ghidul utilizatorului	<b>SR</b> Uputstvo za upotrebu
<b>TR</b> Kullanım kılavuzu	<b>ET</b> Kasutusjuhend	
<b>EL</b> Οδηγός χρήσης	<b>LT</b> Naudotojų vadovas	
<b>PL</b> Instrukcja obsługi		

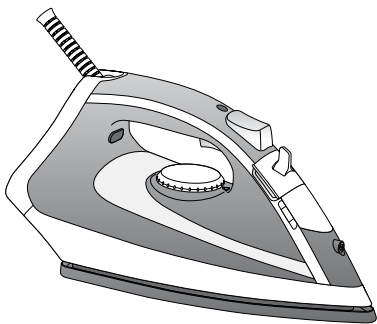

**FR** Pour plus d'informations sur l'utilisation / **EN** For further usage information / **DE** Weitere Informationen zur Bedienung / **NL** Voor meer informatie over het gebruik / **ES** Para obtener más información sobre su uso / **PT** Para obter mais informações sobre a utilização / **IT** Per maggiori informazioni sull'utilizzo / **DA** Yderligere informationer vedrørende betjening / **NO** For mer informasjon om bruken / **SV** För mer information om användningen / **FI** Lisätietoja käyttöä varten / **TR** Kullanım hakkında daha fazla bilgi için / **EL** Για περισσότερες πληροφορίες σχετικά με τη χρήση / **PL** Więcej informacji na temat korzystania z urządzenia / **CS** Pro více informací o použití / **SK** Pre ďalšie informácie o používaní / **HU** A használatra vonatkozó további információk / **SL** Več informacij o uporabi / **RU** Для получения более подробной информации об эксплуатации / **UK** Для отримання детальнішої інформації щодо експлуатації / **HR** Za više informacija o upotrebi / **RO** Pentru mai multe informații privind utilizarea / **ET** Täiendava teabe saamiseks kasutamise kohta / **LT** Daugiau informacijos apie naudojimą / **LV** Lai iegūtu vairāk informācijas par lietošanu / **BG** За още информация относно употребата / **AR** للمزيد من المعلومات عن الاستعمال / **KO** 더 자세한 사용 정보: / **BA** Za više informacija o upotrebi: / **RC** 更多关于使用的信息: / **HK** 更多關於使用的資訊: / **FA** برای کسب اطلاعات بیشتر برای استفاده / **VN** Để biết thêm thông tin về cách sử dụng: / **TH** สำหรับข้อมูลเพิ่มเติมเกี่ยวกับการใช้งาน: / **SR** Za dodatne informacije o korišćenju

www.tefal.com  www.calor.fr

FV17xx



**FR** Veuillez lire attentivement le livret "Consignes de sécurité et d'utilisation" avant la première utilisation / **EN** Please read carefully the «Safety and use instructions» booklet before first use / **DE** Lesen Sie vor dem erstmaligen Gebrauch aufmerksam die Broschüre „Sicherheits- und Bedienungsanweisung“ durch. / **NL** Gelieve vóór het eerste gebruik aandachtig het boekje met de veiligheids- en gebruiksvorschriften door te nemen / **ES** Lea detenidamente el libro «Instrucciones de seguridad y de uso» antes de utilizar el aparato por primera vez / **PT** Leia atentamente o manual «Instruções de segurança e utilização» antes da primeira utilização / **IT** Leggere con attenzione il libretto «Norme di sicurezza e d'uso» al primo utilizzo / **DA** Læs hæftet «Sikkerheds- og brugsanvisning» grundigt igennem inden den første ibrugtagning. / **NO** Les nøye heftet «Råd om sikkerhet og bruk» før første gangs bruk / **SV** Var god läs häftet "Säkerhets- och användningsinstruktioner" innan den första användningen. / **FI** Lue turvallisuuks- ja käyttöohjevihko huolellisesti ennen ensimmäistä käyttökertaa. / **TR** İlk kullanımdan önce «Güvenlik ve kullanım talimatları» kitapçığını dikkatlice okuyun / **EL** Διαβάστε προσεκτικά το εγχειρίδιο «Οδηγίες ασφαλείας και χρήσης» πριν από την πρώτη χρήση / **PL** Przed pierwszym użyciem proszę uważnie przeczytać broszurę „Zalecenia dotyczące bezpieczeństwa i użytkowania” / **CS** Před prvním použitím si, prosím, pečlivě prostudujte „Bezpečnostní pokyny pro použití” / **SK** Pred prvým použitím si pozorne prečítajte „Bezpečnostné odporúčania a použitie”. / **HU** Az első használat előtt figyelmesen olvassa el a „Biztonsági előírások és használati útmutató” című fejezetet / **SL** Pred prvo uporabo natančno preberite »Navodila za varno uporabo« / **RU** Перед первым использованием внимательно прочитайте инструкцию «Меры безопасности и правила использования». / **UK** Перед першим використанням уважно прочитайте посібник «Правила техніки безпеки та рекомендації щодо використання» / **HR** Molimo da prije prve uporabe pažljivo pročitate priručnik „Sigurnosne upute” / **RO** Înainte de prima utilizare, citiți cu atenție manualul „Instrucțiuni de siguranță și de utilizare” / **ET** Palun lugege enne esimest korda kasutamist hoolikalt ohutus- ja kasutusjuhendit / **LT** Atidžiai perskaitykite knygelę „Saugos ir naudojimo reikalavimai” prieš naudodami įrenginį pirmą kartą / **LV** Pirms izmantojat ierīci pirmoreiz, lūdzu rūpīgi izlasiet brošūru «Norādījumi par drošību un lietošanu» / **BG** Моля, прочетете внимателно книжката «Препоръки за безопасност и употреба» преди първоначална употреба / **AR** يرجى قراءة كتيب السلامة وإرشادات الاستعمال بعناية قبل الاستعمال للمرة الأولى / **KO** 처음 사용하기 전, 제품 사용과 관련된 <안전수칙> 책자를 주의 깊게 읽어 주시기 바랍니다 / **BA** Molimo vas da prije prve upotrebe pročitate knjžicu «Uputstva za sigurnost i upotrebu» / **RC** 在第一次使用前请认真阅读此“安全操作规程”手册 / **HK** 在第一次使用前請認真閱讀此“安全操作規程”手冊 / **FA** لطفاً جزوه ایمنی و دستورالعمل استفاده را با دقت بخوانید / **VN** Vui lòng đọc kỹ cuốn «Hướng dẫn Sử dụng và Biện pháp An toàn» trước khi sử dụng lần đầu / **TH** กรุณาอ่านหนังสือคู่มือความปลอดภัยและการใช้งาน» ก่อนการใช้งานครั้งแรก / **SR** pažljivo pročítajte priručnik „Uputstva o bezbednosti i korišćenju” pre prve upotrebe



TURBO

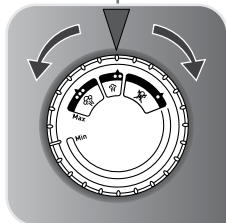
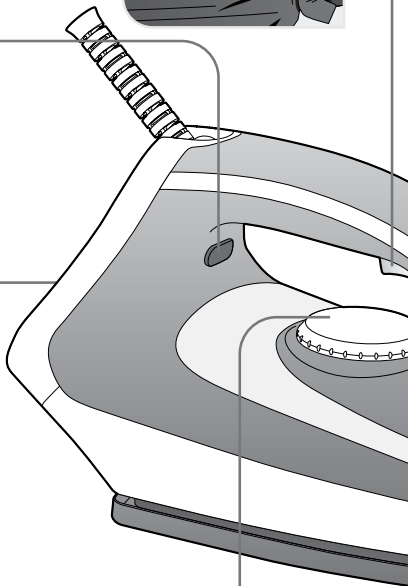
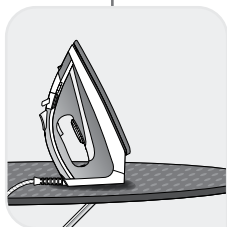
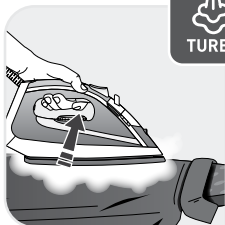
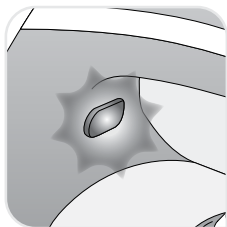

**\*FR** Selon modèle / **EN** Depending on model / **DE** Je nach Modell / **NL** Afhankelijk van het model / **ES** Según modelo / **PT** Consoante o modelo / **IT** Secondo i modelli / **DA** Afhængig af model / **NO** Avhenger av modell / **SV** Beroende på modell / **FI** Mallista riippuen / **TR** Modele göre / **EL** ανάλογα με το μοντέλο / **PL** W zależności od typu / **CS** Podle modelu / **SK** V závislosti od modelu / **HU** Modelltől függően / **SL** Odvisno od modela / **RU** В зависимости от модели / **UK** Залежно від моделі / **HR** Ovisno o mo delu / **RO** Ovisno o modelu / **ET** Sõltuvalt mudelist / **LT** Pagal modelį / **LV** Atbilstoši modelim / **BG** в зависимост от модела / **AR** حسب الموديل / **KO** 모델에 따라 다름 / **BA** Zaviso od modela / **RC** 視型号而定 / **HK** 視型號而定 / **FA** بسته به مدل / **VN** Theo mẫu / **TH** ตามรุ่น / **SR** U zavisnosti od modela

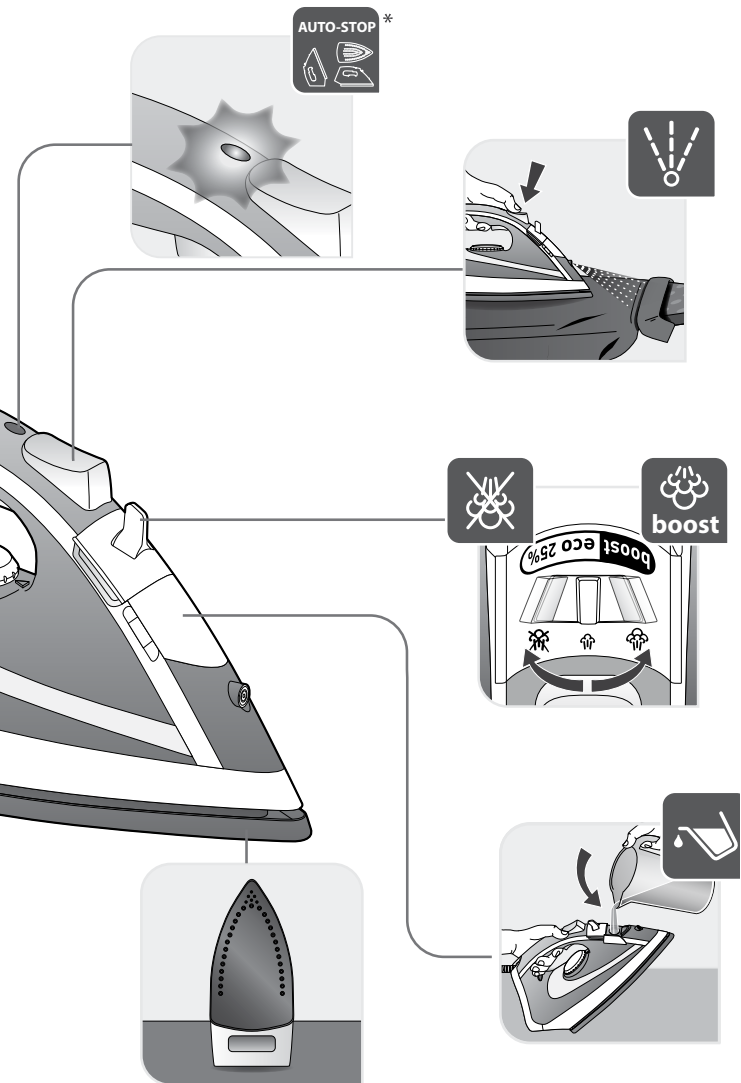

1.

[www.tefal.com](http://www.tefal.com)



[www.calor.fr](http://www.calor.fr)

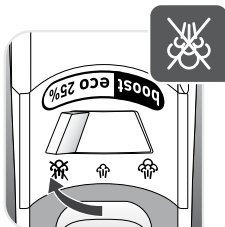

1.

[www.tefal.com](http://www.tefal.com)  [www.color.fr](http://www.color.fr)

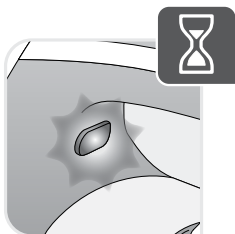
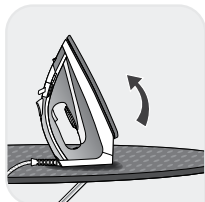
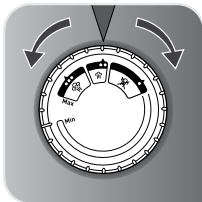
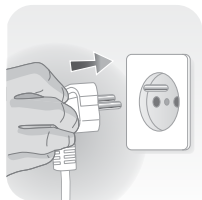

OK

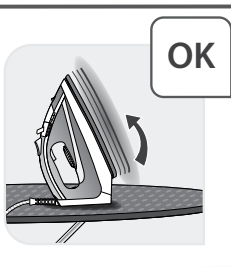

OK

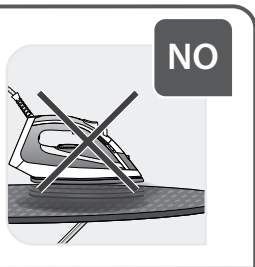

NO

2.

[www.tefal.com](http://www.tefal.com)



[www.calor.fr](http://www.calor.fr)

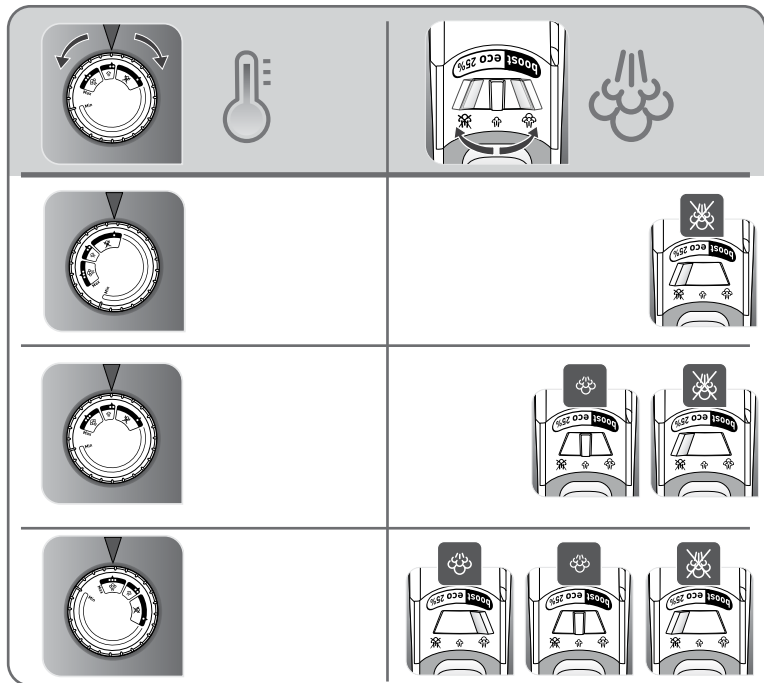
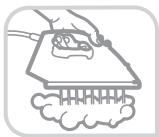



2.

[www.tefal.com](http://www.tefal.com)  [www.calor.fr](http://www.calor.fr)

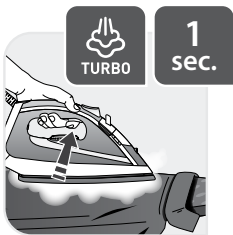
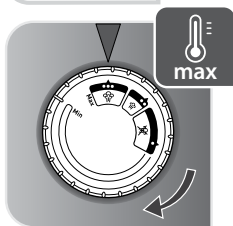
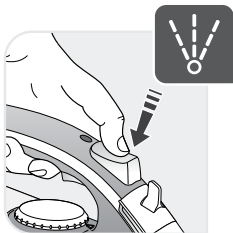

2.

[www.tefal.com](http://www.tefal.com)



[www.calor.fr](http://www.calor.fr)

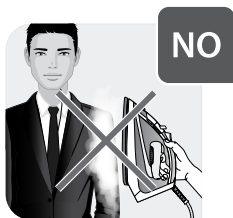
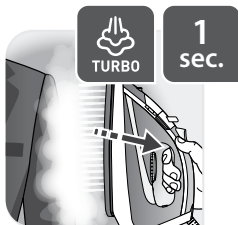
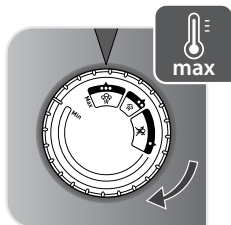
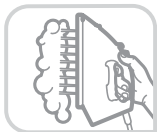

**SAFETY  
AUTO-STOP**

**FR** Selon modèle / **EN** Depending on model / **DE** Je nach Modell / **NL** Afhankelijk van het model / **ES** Según modelo / **PT** Consoante o modelo / **IT** Secondo i modelli / **DA** Afhængig af model / **NO** Avhenger av modell / **SV** Beroende på modell / **FI** Mallista riippuen / **TR** Modele göre / **EL** ανάλογα με το μοντέλο / **PL** W zależności od typu / **CS** Podle modelu / **SK** V závislosti od modelu / **HU** Modelltől függően / **SL** Odvisno od modela / **RU** В зависимости от модели / **UK** Залежно від моделі / **HR** Ovisno o modelu / **RO** Ovisno o modelu / **ET** Sõltuvalt mudelist / **LT** Pagal modelį / **LV** Atbilstoši modelim / **BG** в зависимост от модела / **AR** حسب الموديل / **KO** 모델에 따라 다름 / **BA** Zavisno od modela / **RC** 视型号而定 / **HK** 視型號而定 / **FA** بسته به مدل / **VN** Theo mẫu / **TH** ตามรุ่น / **SR** U zavisnosti od modela

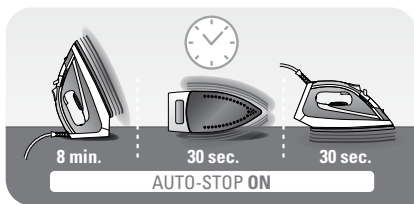
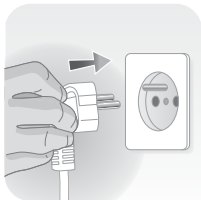

3.

[www.tefal.com](http://www.tefal.com)



[www.color.fr](http://www.color.fr)

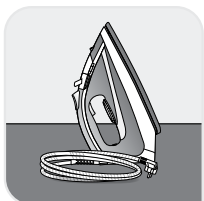
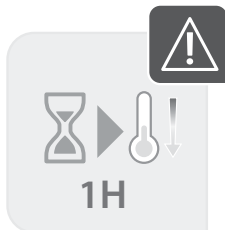
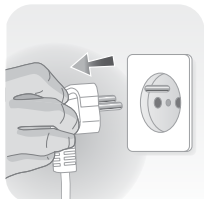
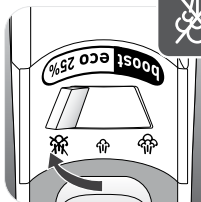

3.

[www.tefal.com](http://www.tefal.com)  [www.calor.fr](http://www.calor.fr)



1H



3.

[www.tefal.com](http://www.tefal.com)



[www.calor.fr](http://www.calor.fr)

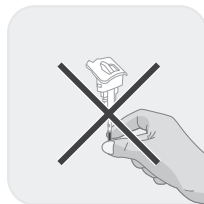
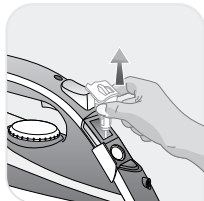
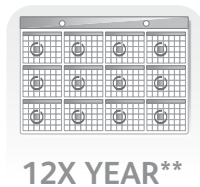

\*\* FR An / EN Year / DE Jahr / NL Jaar / ES Año / PT Ano / IT Anno / DA år / NO år / SV år / FI x / TR yıl / EL έτος / PL Rok / CS Rok / SK rok / HU Év / SL Leto / RU Год / UK Рік / HR Godina / RO An / ET Aasta / LT Metai / LV Gads / BG година / AR عام / KO 년 / BA Godina / RC 新年 / HK 年 / FA سال / VN Năm / TH ปี / SR Godina

3.

[www.tefal.com](http://www.tefal.com)



[www.calor.fr](http://www.calor.fr)

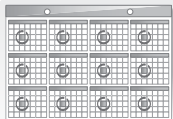

12X YEAR\*\*

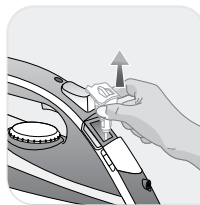
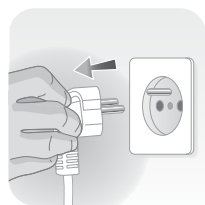
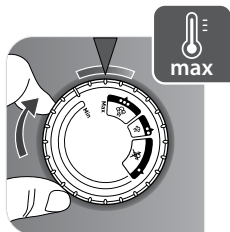
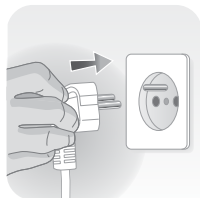

\*\* FR An / EN Year / DE Jahr / NL Jaar / ES Año / PT Ano / IT Anno / DA år / NO år / SV år / FI x / TR yıl / EL έτος / PL Rok / CS Rok / SK rok / HU Év / SL Leto / RU Год / UK Рік / HR Godina / RO An / ET Aasta / LT Metai / LV Gads / BG година / AR عام / KO 년 / BA Godina / RC 新年 / HK 年 / FA سال / VN Năm / TH ปี / SR Godina

3.

[www.tefal.com](http://www.tefal.com)  [www.calor.fr](http://www.calor.fr)

